



MaxAW05-Series

Small Servo Robot
IMM RANGE 280 – 300 Ton



MaxAW05-1100P	Standard		Metric	
Movement	drive type	Servo Telescoping Vertical Arm	Servo Telescoping Vertical Arm	drive type
IMM Range	tons	280 - 300	2491 - 2669	kn
Vertical Stroke	in	43.31	1100	mm
Single Arm Strip	in	47.24	1200	mm
Traverse	in	70.87	1800	mm
Gripper Angle	°	90	90	°
Max Load	lbs	13.23	6	kg
Drive System	drive	AC Servo Motor	AC Servo Motor	drive
Working Air Pressure	psi	71.12 ~ 113.81	5 ~ 8	kg/cm ²
Air Consumption	fluid oz	3.38E-08	1	NL/cycle
Power Consumption	KVA	3.4	3.4	KVA
Power Supply	power supply	480VAC - 3 Phase - 60 Hz	480VAC - 3 Phase - 60 Hz	power supply



MaxAW05-Series

Small Servo Robot
IMM RANGE 280 – 300 Ton

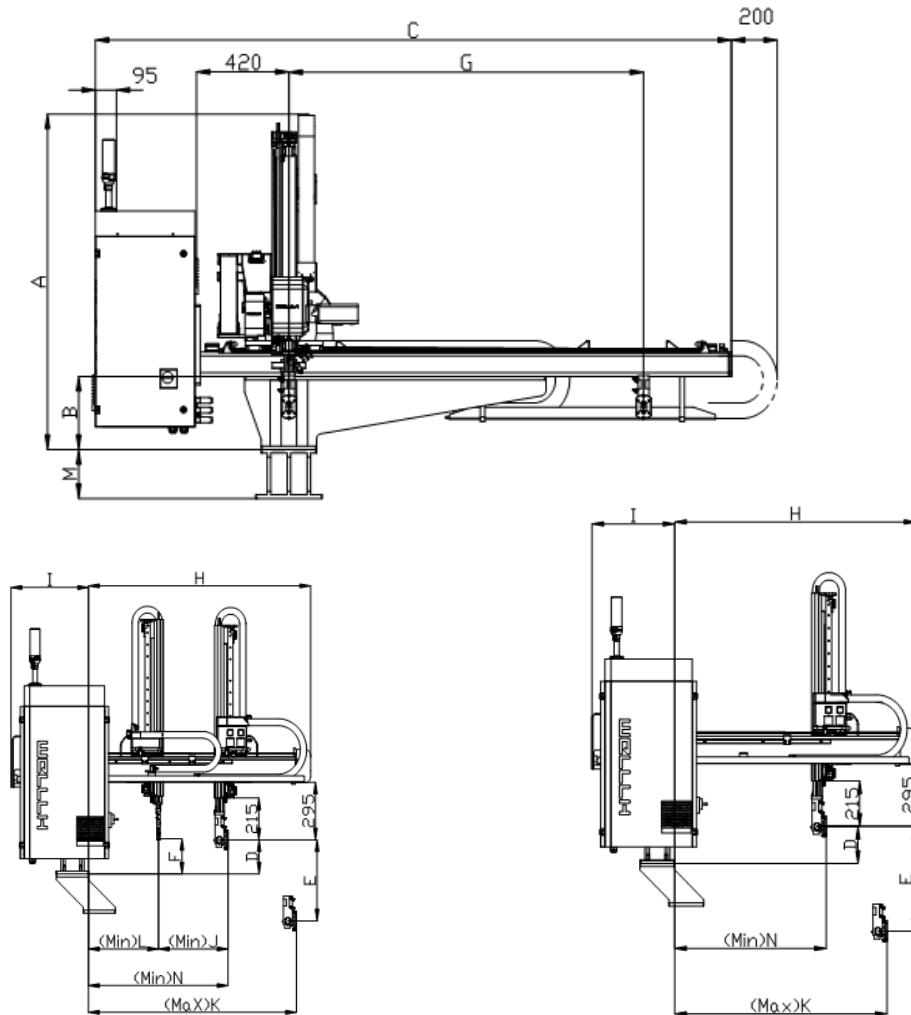

MaxAW05-1100P	Standard (in)	Metric (mm)
A	55.91	1420
B	11.81	300
C	118.11	3000
D	7.09	180
E	43.31	1100
G	70.87	1800
H	57.09	1450
I	17.13	435
K	47.24	1200
M	7.87	200
N	6.3	160

Specifications subject to change due to technical advances